

**BELCO** 

# BELCO FOREST PRODUCTS PRODUCT CATALOG

Belco XT® Products- The Anti-Rot  
Exterior Trim Game Changer

2ND EDITION/JAN 2025





# CONTENTS

<b>WHO WE ARE - The Belco People .....</b>	<b>03</b>
<b>WHAT WE DO - The Belco XT® Products .....</b>	<b>04</b>
• Belco XT Applications	
• Belco XT Trim	
• Belco XT Post	
• Belco XT Plowed Fascia	
• Belco XT Corner Trim	
<b>HOW WE DO IT - The Belco Process .....</b>	<b>12</b>
• The Belco Difference: Preservative Treatment and Priming Process	
• The Belco Promise: On Grade, On Time, Every Time	
• The Belco Warranty: Non-Prorated, No Nonsense	
<b>WHY WE DO IT - The Belco Difference .....</b>	<b>15</b>
<b>FAQs .....</b>	<b>16</b>
<b>WHERE WE ARE - The Belco Reach.....</b>	<b>17</b>



# WHO WE ARE:

## The Belco People

### Setting the Standard Since 1978

Located in the heart of the Pacific Northwest near the Olympic Mountains, Belco Forest Products has become a leader in treated exterior millwork, serving residential and commercial construction projects with a commitment to excellence that shapes every product and every partnership. Our roots are deep in the rich timber traditions of the Shelton, Washington area, and our values reflect a passion for quality, integrity, and sustainable stewardship. These values impact our innovative commitments to build premium products, experiences, and people.

**Our mission, to enrich the lives of our employees, has nurtured an environment where individuals are encouraged to learn, grow, and make a meaningful impact. This commitment to our employees translates directly into the quality of our products and the service we provide to our customers. By fostering a sense of pride and purpose among our people, Belco delivers reliable, high-performance, exterior treated wood trim products that guarantee successful partnerships and projects.**

Grounded in our core value of integrity, we uphold an On Grade, On Time, Every Time promise, committing to operational excellence and data-driven insights and results. This ensures we consistently deliver precision, reliability, and trust. It's simple. At Belco, we do what we say we will do.

Belco not only meets the needs of dealers, builders, and distributors, we anticipate them. With our eco-friendly preservative-treated, primed Belco XT products, we provide anti-rot, "one and done" game changing solutions that address common challenges in construction, saving both time and money.

**Choosing Belco means choosing more than a product; it means choosing a partner who cares about the communities we build and the people who build them.**



# WHAT WE DO:

## Belco XT® Products

Naturally beautiful, built to last - We don't just play the game, we change it!

Today, solid wood remains one of the most attractive and cost-effective exterior millwork choices for construction projects, and Belco is leading the charge. Our preservative treated and primed trim products not only provide a beautiful touch to the exterior of the home but also long-lasting peace of mind.

The Belco XT family of products provides customers with durable, solid wood exterior millwork, perfect for trim applications requiring long-lasting, rot-resistant, weatherproof, and pest-resistant materials.



### PRESERVATIVE and PRIME TREATMENT featuring WOLMAN® AG

- EPA approved, nonmetallic, wood preservative treatment ensuring a pest and rot-resistant substrate.
- Primed and sealed on all 6 sides, every board arrives ready for installation and finishing
- End spray applied to limit boards with unusable end splits

The High Points:

#### FUNCTIONAL

- Available in widths and lengths to meet all your exterior trim needs
- Multiple textures available to fit any aesthetic
- Lightweight for easier installation
- 20-year warranty against rot, mold and mildew

#### COST EFFECTIVE

- Pre-primed, saves time and money during installation
- Metal free, non-corrosive treatment means no special tools or fasteners
- Less costly than cedar, redwood, fiber cement or composite alternatives
- Highly stable, tight-knot, appearance grade SPF substrate

#### IDEAL FOR

- Exterior trim & fascia
- Corner boards
- Garage door liners
- Belly band
- Rake/frieze board
- Drip edge

**AND MORE!**

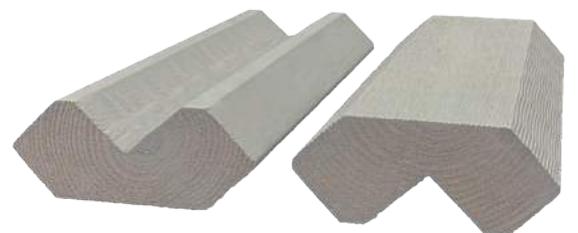



BELCO 

# BELCO EXTERIOR TREATED PRODUCTS





## Naturally Beautiful. Built to Last.

Today, solid wood remains one of the most attractive and cost effective exterior millwork choices for construction projects.

And Belco's preservative treated XT Trim is leading the charge. With a 20-year limited warranty, Belco XT Trim products not only provide a beautiful touch to the exterior of the home but also long-lasting peace of mind.



Manufactured by Belco Forest Products  
P: 360.426.8900 | belcofp.com

## BELCO XT<sup>®</sup> TRIM

### PRESERVATIVE TREATMENT - WOLMAN<sup>®</sup> AG

- ▲ A water-based, nonmetallic, wood preservative surface treatment
- ▲ Wolman<sup>®</sup> AG is an EPA approved treatment

### FUNCTIONAL

- ▲ Available in widths and lengths to meet all your exterior trim needs
- ▲ Lightweight for easier installation
- ▲ 20-year warranty against rot

### COST EFFECTIVE

- ▲ Pre-primed, saves time and money during installation
- ▲ Metal free, non-corrosive treatment means no special tools or fasteners
- ▲ Less costly than cedar, redwood, fiber cement or composite alternatives
- ▲ Highly stable, tight-knot, appearance grade SPF substrate

---

Thicknesses: 1", 5/4", 2"

Widths: 2" - 12"

Lengths: 8' - 20'

Textures: Comb face, comb 4 sides, resawn face

---

### IDEAL FOR:

- ▲ Exterior trim & fascia
- ▲ Corner boards
- ▲ Garage door liners
- ▲ Bellyband
- ▲ Rake/frieze board
- ▲ Drip edge



## One and Done Solution

Today, wood remains one of the most attractive and cost effective choices for construction projects. Belco's preservative treated XT Post is leading the charge. With a 20-year limited warranty, XT Post products not only provide you with a beautiful, single step solution for post installation but also longlasting peace of mind.



Manufactured by Belco Forest Products  
P: 360.426.8900 | belcofp.com

## BELCO XT® POST

### PRESERVATIVE TREATMENT - WOLMAN® AG

- ▲ A water-based, nonmetallic, wood preservative surface treatment
- ▲ Wolman® AG is an EPA approved treatment

### FUNCTIONAL

- ▲ Structural engineered columns provide greater stability, less warp, and reduced potential for checking than solid timber or hollow posts
- ▲ 6x6 and 8x8 products come standard with a conduit chase for lighting installation

### COST EFFECTIVE

- ▲ Pre-primed, trimmed out post saves time and money during installation — no more column wrapping
- ▲ Metal free, non-corrosive treatment means no special tools or fasteners
- ▲ Less costly than fiberglass or aluminum alternatives

---

4x4 XT Post  
Net: 3-1/2" x 3-1/2"  
Lengths: 10', 12'  
Texture: Combed

8x8 XT Post  
Net: 7" x 7-1/4"  
Lengths: 10', 12'  
Texture: Combed

6x6 XT Post  
Net: 5 x 5 1/2"  
Lengths: 8', 10', 12'  
Texture: Combed

---

### IDEAL FOR:

- ▲ Porch posts
- ▲ Rail posts
- ▲ Gazebos
- ▲ Knee Braces
- ▲ Corbels



## EXTERIOR POST PRODUCT

Allowable Axial Load Capacities

Column Length (ft)	4X4			6X6			8X8		
	C <sub>D</sub> =1.0	C <sub>D</sub> =1.15	C <sub>D</sub> =1.25	C <sub>D</sub> =1.0	C <sub>D</sub> =1.15	C <sub>D</sub> =1.25	C <sub>D</sub> =1.0	C <sub>D</sub> =1.15	C <sub>D</sub> =1.25
10	2452	2820	3065	9774	11240	12217	19239	22125	24049
	1695	1950	2119	8405	9666	10507	18333	21083	22916
	1212	1393	1515	6678	7679	8347	16790	19309	20988

- 1 All allowable load capacities are determined for compression only in accordance with the Design Values as published in the APA Product Report PR-L321. Allowable load capacities assume dry use, untreated applications in sustained exposure of temperatures < 100°F (38°C).
- 2 For wet service conditions the allowable axial capacity should be multiplied by CM = 0.73.
- 3 For service conditions above 100°F (38°C), the allowable axial capacity should be multiplied by the appropriate Ct factor in Table 2.3.3 of the National Design Specification for Wood Construction.
- 4 Table assumes that effective column length is equal to actual column length and end conditions are rotation free, translation fixed.

### INSTALLING

#### UPLIFT APPLICATION

When Belco XT Post has been designed for use in an uplift application, post bases and caps are REQUIRED. Belco recommends Simpson Strong Tie products but products of equal properties are accepted. Refer to base and cap manufacturer's instructions for capacities and connector attachment.

Raised Base Connection



Column Base Connection



Column Cap Connection



#### VERTICAL LOAD ONLY APPLICATION

When Belco XT Post has been designed for use in a vertical load only application, a nailed connection can be implemented.



# BELCO XT® PLOWED FASCIA APPLICATION

### FEATURES

- Single Step Fascia
- ▲ A structural tie for rafters and outlookers
- ▲ Appearance graded and ready for paint
- ▲ Primed all 6 sides
- ▲ EPA registered wood preservative
- ▲ Square-edges for sharp shadow lines

### BENEFITS

- Cost Effective
- ▲ Installs with framing package — one trade only
- ▲ Fast and efficient — 18-foot lengths are 12% longer than engineered wood and 50% longer than fiber cement
- ▲ Fewer seams means fewer gaps for moisture intrusion
- ▲ Beauty cap and structural trim all-in-one
- ▲ Scarf joints allowed — unlike fiber cement and engineered woods



## One and Done Solution

Today, wood remains one of the most attractive and cost effective choices for construction projects. Belco's preservative treated XT Plowed Fascia is leading the charge. With a 20-year limited warranty, XT Plowed Fascia products not only provide you with a beautiful, single step solution for installation but also long lasting peace of mind.

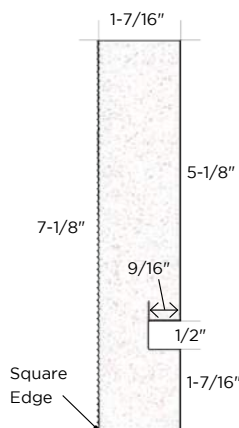

**2X8 XT PLOWED FASCIA**

**Net:** 1 7/16 x 7 1/8  
**Lengths:** 16' 18'  
**Texture:** Comb, Smooth

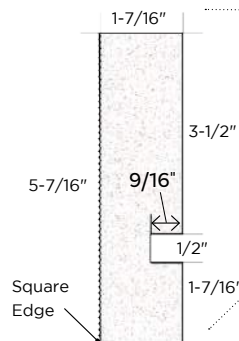

**2X6 XT PLOWED FASCIA**

**Net:** 1 7/16 x 5 7/16  
**Lengths:** 16' 18'  
**Texture:** Comb

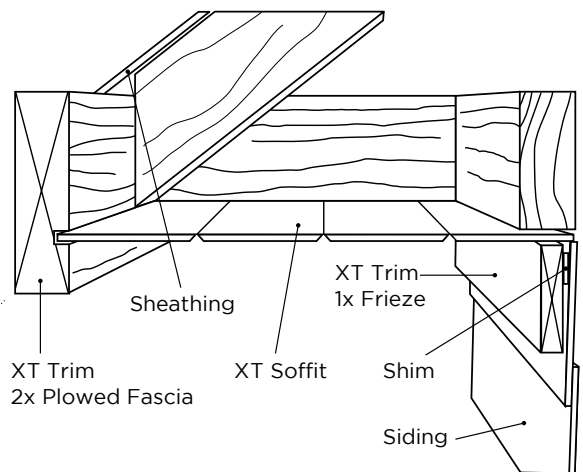



## One and Done Corner Solution

Today, wood remains one of the most attractive and cost-effective choices for construction projects.

Belco's preservative treated Belco XT Corner Trim is leading the way. With a 20-year limited warranty, Belco XT Corner Trim not only provides a beautiful, single-step, gap-free solution for inside and outside corner trim, but also long-lasting peace of mind.



Manufactured by Belco Forest Products  
P: 360.426.8900 | belcofp.com

### BELCO APPLICATIONS

## BELCO XT® CORNER TRIM

### PRESERVATIVE TREATMENT - WOLMAN® AG

- ▲ A water-based, nonmetallic, wood preservative surface treatment
- ▲ Wolman® AG is an EPA approved treatment

### FUNCTIONAL

- ▲ One-piece corners provide excellent resistance to wind-driven rain—fewer joints to maintain
- ▲ Cohesive single unit as opposed to separate pieces subject to variable movement

### COST EFFECTIVE

- ▲ Pre-primed, one-piece, corners save time and money during installation— half the sticks at every corner
- ▲ Metal free, non-corrosive treatment means no special tools or fasteners
- ▲ Less costly than PVC, fiber cement, or aluminum alternatives

### 2x4 XT Corner

Net: 1.438" x 3.313"

Lengths: 10', 20'

Texture: Combed

### IDEAL FOR:

- ▲ 1 and 2 story applications
- ▲ Inside exterior corners
- ▲ Outside exterior corners

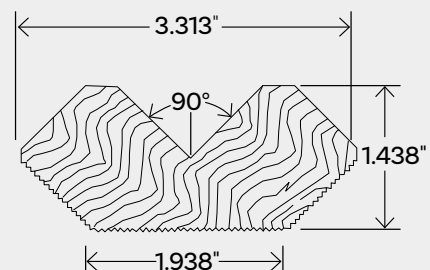

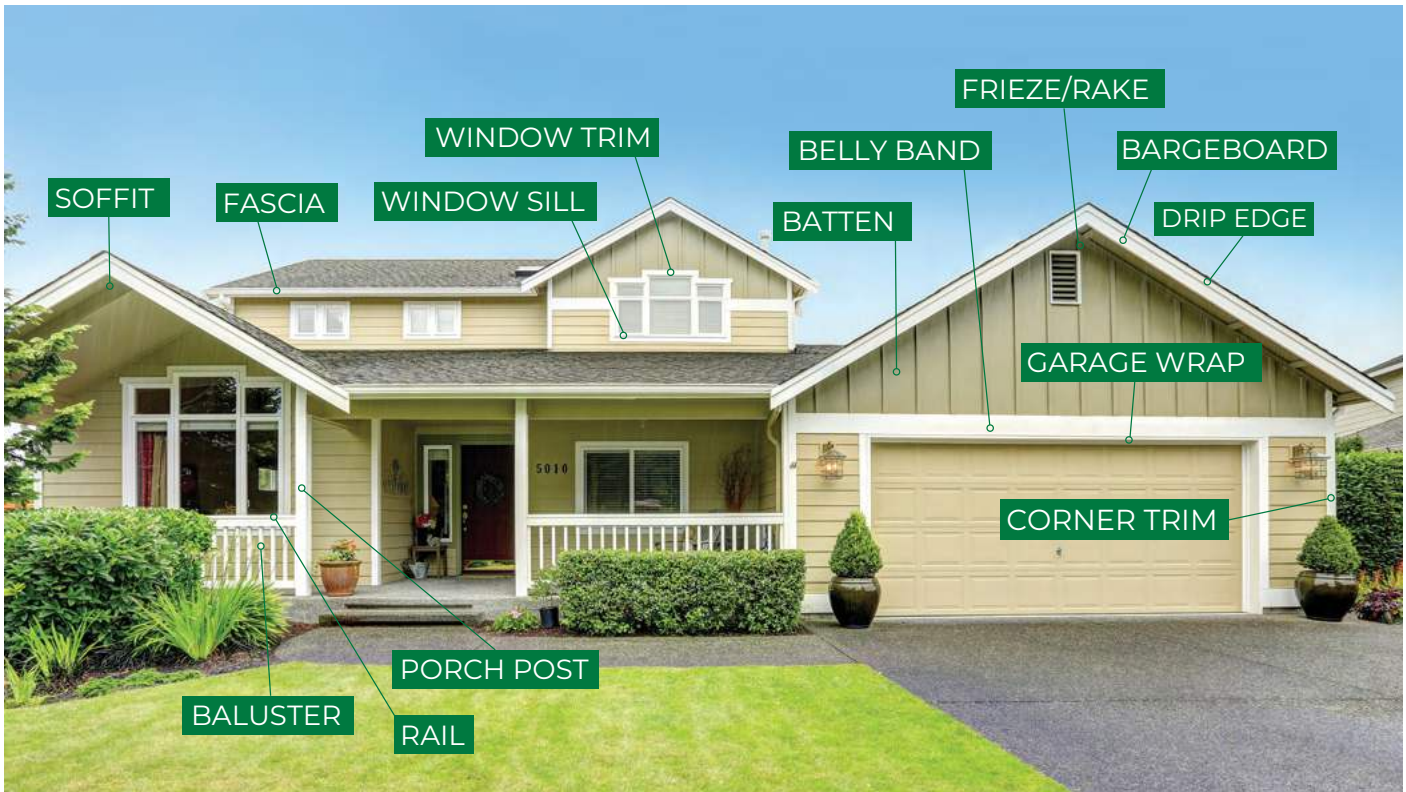

## BELCO APPLICATIONS

# BELCO XT® PRESERVATIVE TREATED PRODUCTS

- ▲ **BATTEN** – Narrow strips of wood used to cover joints or as decorative vertical members over plywood or wide boards. Typically 1x2, 1x3
- ▲ **BALUSTER / RAIL** – Vertical and horizontal members in a balustrade. Typically 2x2, 2x4
- ▲ **BARGEBOARD** – Exterior house trim along a gable. Typically 2x8
- ▲ **BELLY BAND** – The nontechnical term for decorative cladding that runs horizontally around a house or building. It usually runs around the building at about the height of the first or second floor. Typically 2x10, 2x12
- ▲ **CORNER TRIM** – Decorative trim to help protect the corners where siding joints come together. Typically 5/4x3, 5/4x4

- ▲ **DRIP EDGE** – Trim strip under the roof edge installed on fascia and bargeboard (gable end fascia) to protect against moisture intrusion. Typically 1x2
- ▲ **FASCIA** – Horizontal boards attached to rafter/truss ends at the eaves and along gables. Typically 2x8
- ▲ **FRIEZE/RAKE** – Trim member connecting the siding with the soffit. Typically 1x4
- ▲ **GARAGE WRAP** – Decorative trim enclosing the garage framing members Typically 2x8
- ▲ **POST** – Structural column for porches and decks. Typically 6x6
- ▲ **WINDOW TRIM AND WINDOW SILL** – Decorative trim elements for windows and doors. Typically 2x3 (sill), 1x3 (trim)
- ▲ **SOFFIT** – A decorative covering consisting of interlocked T&G boards to add depth and texture to exterior ceilings and overhangs. Typically 1x2, 1x3



# HOW WE DO IT: BELCO PROCESSES

## The Belco Difference: Preservative Treatment and Priming Process.

Our true two-step treatment process sets the foundation for durable, trustworthy wood trim that's built to withstand the elements.

### Belco XT®: Advanced Two-Step Treatment Process

It's all in the details. Our innovative two-step treatment process isn't an added feature; it's the very essence of every Belco product. We buy kiln-dried premium home center lumber. This minimizes warping, shrinking, and swelling, ensuring our wood stays stable and strong from the inside out. Many competitors only use a surface sealant, but our approach fortifies each fiber with long-lasting protection against fungi, insects, and moisture.



#### STEP ONE:

##### Deep Preservative Protection

Each board undergoes preservative treatment with Wolman® AG—a trusted, non-metallic, EPA-approved solution. By treating wood at its core, we ensure that Belco XT Trim stands up to the toughest conditions without compromising on safety or environmental standards. We don't believe treatment should come with an additional cost, which is why at Belco, all products are treated as a standard.



#### STEP TWO:

##### SUPERIOR PRIME COAT

Next, we finish with a factory-applied, proprietary water-based primer designed for exceptional adhesion and moisture resistance, setting up each piece for easy finishing on the job site.



METAL-FREE  
WOOD PRESERVATIVE

# THE BELCO PROMISE: ON GRADE, ON TIME, EVERY TIME

Belco's dedication to quality goes beyond our products to include our promise of dependable, on-time delivery. We understand that reliable supply chains are essential to the success of any building project, while we pride ourselves on our products, Belco's commitment to operational excellence and logistics is just another reason we're different.



## On-Time Delivery

Even during high-demand periods, Belco promises consistent product availability. Our commitment to operational excellence allows us to fulfill orders without delay, eliminating the headaches and inevitable profit drain of backorders and missed deadlines. While many companies promise this, Belco measures and reports our on-time delivery rate, keeping us accountable and your trim products on time.



## Lower Operating Costs & Higher Value

When Belco commits to a partner, we're 100% dedicated. Our strategic Belco programs translate to lower operating costs for our dealers and product loyalty from our builders.



## No Unusable Product

Quality control is central to Belco. With our on-site grading standards, we ensure that every board meets our high standards for performance, reducing fall-down and minimizing the need for replacements or callbacks.

Want to up the ante?  
Just ask about our  
**ZERO LIABILITY Dealer Programs!**





## THE BELCO WARRANTY: NON-PORATED, NO NONSENSE

Belco's Limited 20-Year Non-Prorated Warranty is designed to protect builders and homeowners by providing unmatched value and peace of mind. Unlike many industry standard warranties that diminish over time, Belco ensures consistent, full coverage for two decades, with no reductions in protection for the builder and original homeowner. This demonstrates our confidence in Belco XT products and represents the "transfer of risk" from dealer/builder to manufacturer, meaning we take responsibility, not you. By choosing Belco, dealers and builders benefit from positive risk management, reduced service costs, and increased customer satisfaction. This builds trust and confidence, paving the way for customer loyalty.





# WHY WE DO IT: BELCO HIGHLIGHT REEL

Hear more from our happy customers!



“We have used Belco XT Trim and Posts for over four years. We’ve not had a single callback problem associated with their products.

That says a lot particularly because it’s a natural wood product placed in highly visible locations.

**We like their 20-year warranty, consistent quality and local service. Belco is one of those suppliers that you never have to worry about.”**

GILBERTO BARERRA  
VP PURCHASING  
CHESMAR HOMES



**“They’ve just brought great product, great service, and just dependability with the products coming in, the stability of the product itself, and the quality overall.”**

SCOT SAVARY,  
MARKET MANAGER  
BUILDERS FIRSTSOURCE.



**“We brought Belco on over a year ago and our customers are very happy. They have great service and their primed trim is high quality. We made the right decision.”**

STEVE SELLERS, BUSINESS  
DEVELOPMENT  
TEXAS BUILDING SUPPLY SAN ANTONIO



# FAQs

## **What makes Belco's two-step treatment process different from other treated wood products?**

Belco's two-step treatment process allows our preservative treatment to deeply penetrate wood fibers. This is followed by a high-performance primer application that adds an extra layer of protection and moisture resistance. Unlike competitors who often use surface sealants, Belco's method fortifies wood from within, delivering exceptional durability against fungi, insects, and moisture for long-lasting results.

## **What is the "On Grade, On Time, Every Time" promise?**

Our "On Grade, On Time, Every Time" promise reflects Belco's commitment to reliability and customer satisfaction. We guarantee that our products will be available without backorders or allocations, and every piece of wood meets

ensuring they receive usable, high-quality materials right when they need them.

## **What is the benefit of the non-prorated warranty?**

Belco's 20-Year Non-Prorated Warranty is our commitment to standing behind the quality of our products. Unlike prorated warranties that decrease in coverage over time, our warranty provides full coverage for two decades, offering builders and homeowners consistent protection and peace of mind. This warranty demonstrates our confidence in Belco XT products and represents a shift of responsibility from the builder to us, making it a valuable risk management asset.

## **What kind of protection does Belco XT Trim offer?**

Belco XT Trim provides comprehensive protection against environmental threats, including fungi, mildew, insects, rot, and marine borers. Our preservative-treated wood trim uses Wolman® AG, an EPA-approved non-metallic preservative, to protect wood fibers from within. Combined with our durable primer, Belco XT Trim is designed for long-lasting performance in all above-ground applications.

## **How does Belco's product availability benefit my business?**

Belco ensures product availability even in high-demand periods, which means no backorders, no allocations, and consistent stock for our customers. Our commitment to inventory management helps builders, dealers, and distributors avoid project delays, manage costs, and maintain smooth operations.



# WHERE YOU CAN FIND US: THE BELCO REACH

## Dealer Map

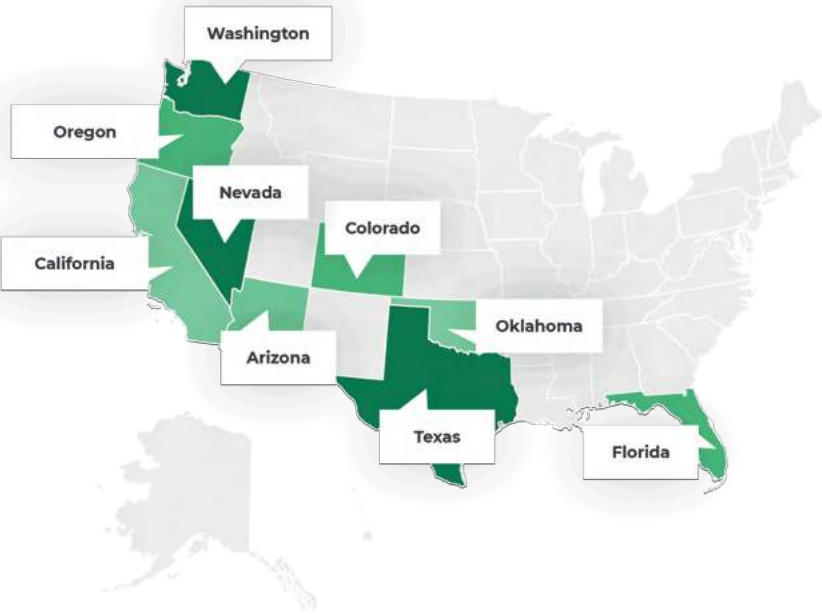

Use our Locator Tool to find a dealer near you!



P: 360.426.8900

[belcofp.com](http://belcofp.com)

[sales@belcofp.com](mailto:sales@belcofp.com)

1890 East Johns Prairie Road,  
Shelton, WA 98584





At Belco Forest Products, sustainability is woven into everything we do. Our preservative treatment is environmentally friendly, and we maximize our resources by repurposing by products into usable forms. Beyond production, we contribute to climate research, invest in air-quality improvements, and proudly partner with environmentally focused organizations to restore natural habitats and offset carbon emissions. Together, we're making strides toward a healthier, more sustainable future, one that benefits both our community and the earth.



P: 360.426.8900  
belcofp.com  
sales@belcofp.com  
1890 East Johns  
Prairie Road,  
Shelton, WA 98584

